



ALPHA

SERIES

CUSTOM BODY

WILL FIT CLUB CAR® PRECEDENT®
INSTALLATION INSTRUCTIONS

Body Kits Include:

- Front Cowl and Rear Body
- Automotive Style Flush Mount LED Headlights and Tail Lights
- Off-Road Style Front Grill
- Color Infused Injection Molded Flexible Plastic
- High Gloss Clear Coat Finish



ALPHA CUSTOM BODY INCLUDES



Cowl



Rear Body

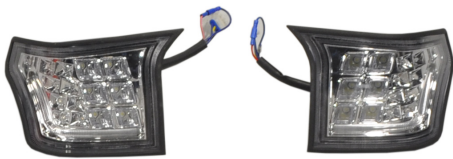

Headlights



Alpha Front Harness



Front Cowl Bracket (05-057)



Light Mounting Brackets

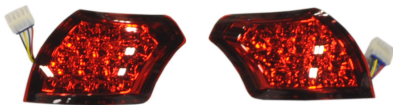

Tail Lights



Alpha Bucket Harness



Frame Extenders (05-063)



Hardware Packs

Off-Road
Grill
(05-021)



OR

Street Grill
Red: 05-036
White: 05-037
Blue: 05-038
Black: 05-039



OR

Black
Off-Road Grill
(05-083)



Hood Scoop
(Sold Separately)

Red: 05-041
White: 05-044
Blue: 05-042
Black: 05-043



1

Switch key to OFF position. Place TOW/RUN switch to TOW. It is not required to remove the batteries but you do need to disconnect the main negative.



Remove factory canopy and struts. Retain hardware. Remove rear seat kit if applicable. Front tires have been removed for instructional purposes only.

2

3

Remove 4 screws around front brow and retain. Remove front brow, then front cowl.



Remove front fascia by temporarily removing cowl support. Once front fascia is removed, reattach cowl support. Remove front OEM bumper or light kit at this time.

4

COWL ASSEMBLY



Note: If installing a hood scoop follow the next two step, otherwise skip to step 7.

5

Flip the cowl over and locate the 6 dimples located underneath the cowl.



Using the 6 small screws and washers included with the hood scoop, attach the hood scoop to the cowl from underneath. Attach with a Phillip's screwdriver by hand tightening. **(Do not overtighten)**

6

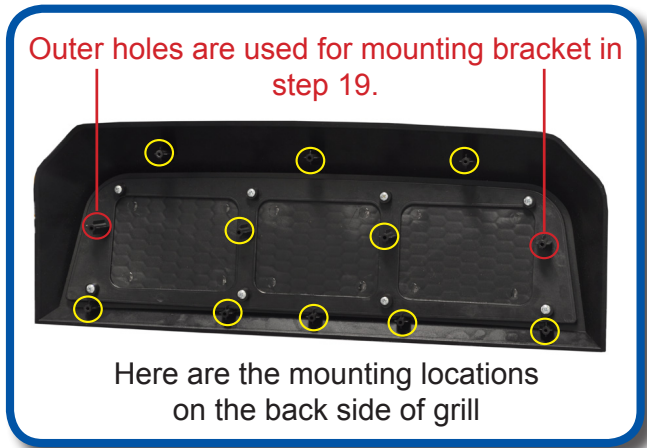
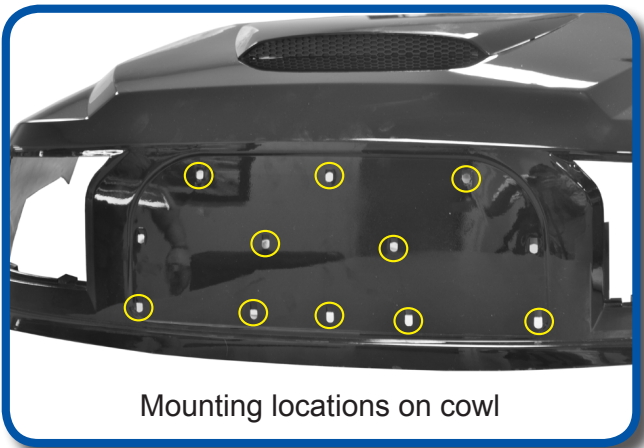

Attach the grill to the front of the cowl using the supplied hardware. Both the street and off road grills attach exactly the same. Use the 5/8" screws and flat washers from hardware pack #1

Note: Flip cowl over and place on a flat surface with a soft material between the two to avoid scratching.

Attach grill using hardware provided. Attach with a Phillip's screwdriver by hand tightening.. **(do not overtighten)**

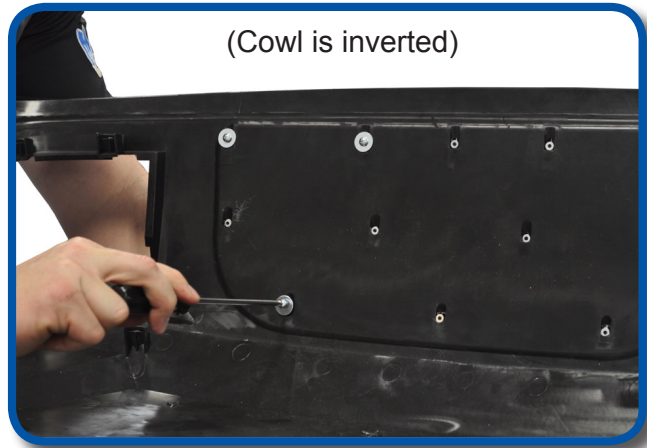

10

To mount the front headlights, the 8 small brackets pictured will be used.

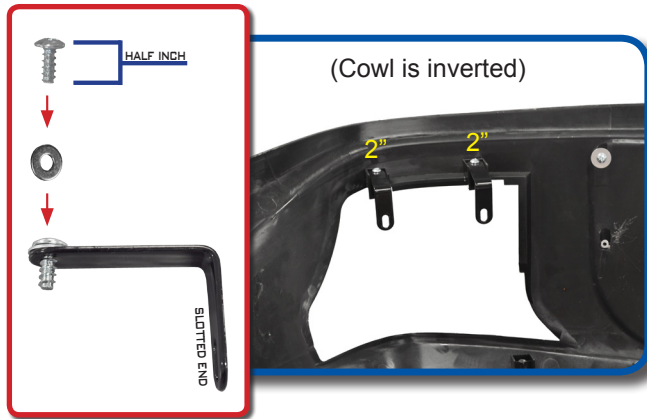
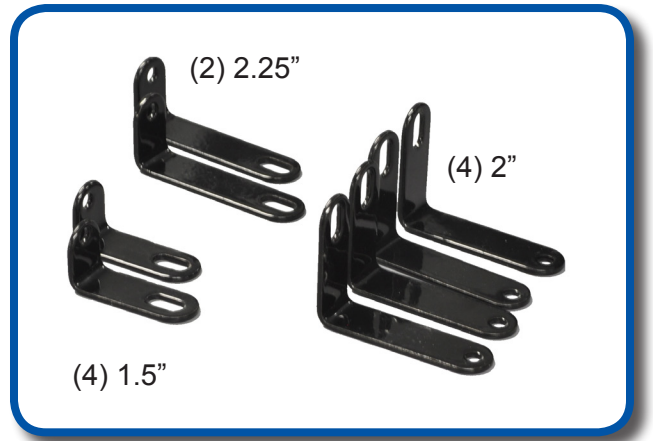

Attach two of the 2" headlight brackets to the cowl using the large head **half inch screw** as shown. Be sure that the slotted holes are facing towards the inside.

11

Attach smallest 1.5" (L) bracket to top inside mounting tab. Attach 2.25" (L) bracket to remaining mounting tab. Be sure that the slotted holes are facing towards the inside.

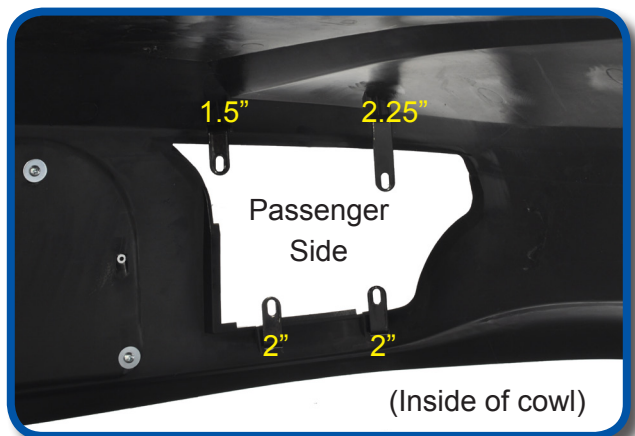
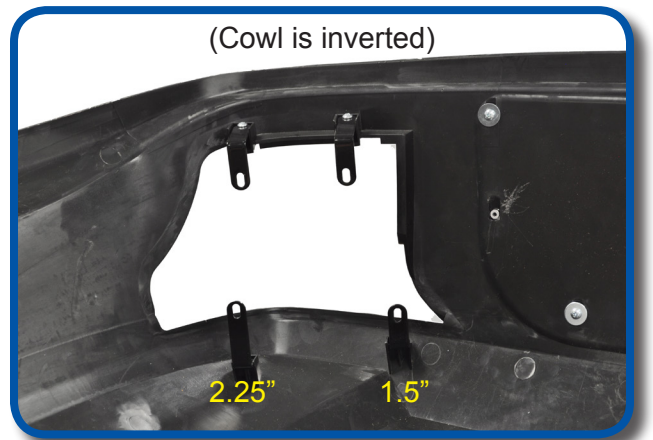

With cowl flipped over, be sure your light tab bracket locations are the same as the picture shown.

13

14

Insert light through the front side of the cowl. Using the 1 inch screws and springs from hardware pack, attach the headlight to the mounting tabs as shown.



15

Be sure the screws and springs are attached as shown with the springs between the light housing and mounting brackets. If lights are not lining up flush, loosen screws and adjust accordingly. Repeat process on the other side.



16

Attach the shorter of the two cowl angle brackets to the middle mounting bracket as shown. Use the supplied hardware and tighten.

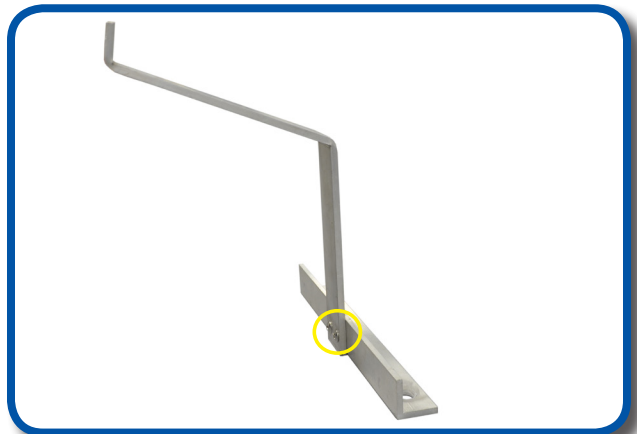

NOTICE

COWL ASSEMBLY ADDENDUM

1

Insert Carriage Head Bolts In Cowl at shown locations

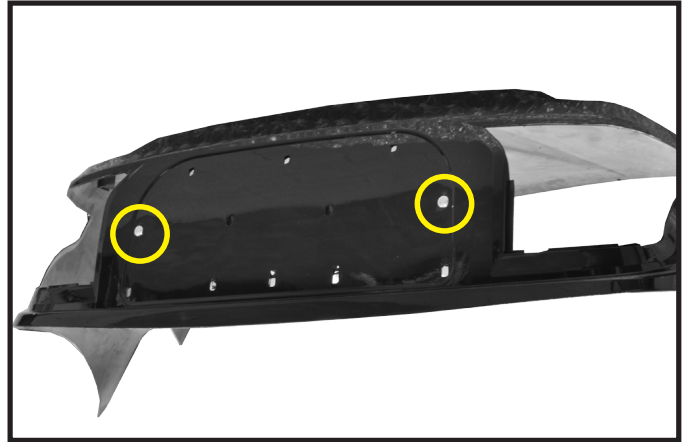

2

Attach grill to cowl

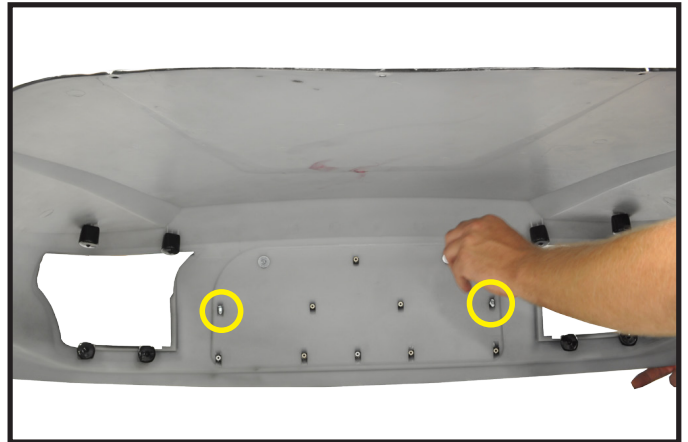

3

Install bracket to carriage bolts with hardware provided.



END OF ADDENDUM



17
Attach the longer angle bracket using remaining hardware as shown. This bracket will attach to the cowl in the next step.

18
Using the remaining hardware from pack #1, attach mounting bracket to cowl/grill as shown.



(Cowl is inverted)



19
Assembled bracket should resemble the picture shown.

Now that the cowl is fully assembled, we are ready to attach the cowl to the cart.

20
Insert frame extensions into the frame next. With the channel side of the frame extension facing up, slide into frame as shown.

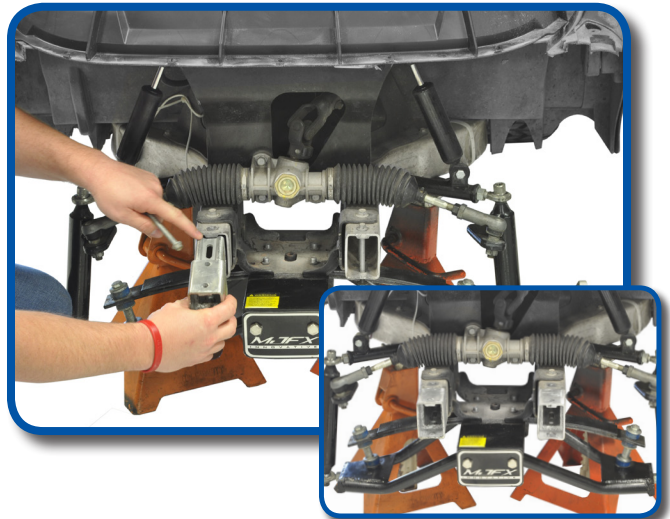



With an assistant's help, place the cowl over the front underbody. The cowl mounting bracket should attach to the OEM mounting points on the frame that attaches the OEM bumper / light bumper.

Using the hardware from pack #2, attach the cowl to the front underbody as shown. Ensure that the screws are flat and do not overtighten.



Using hardware from pack #2, attach light bar or OEM bumper to frame extensions.

Note: If you are installing the Armor Bumper designed for this cowl (part #14-018) do so now.

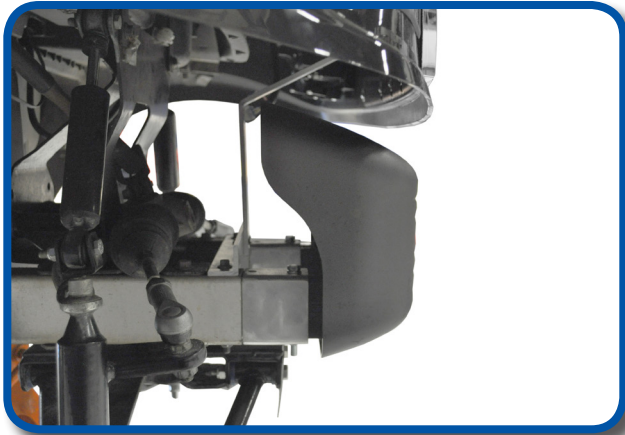

Using retained hardware from step 3, reattach brow over new cowl.



FRONT COWL COMPLETE

REAR BODY TEAR DOWN

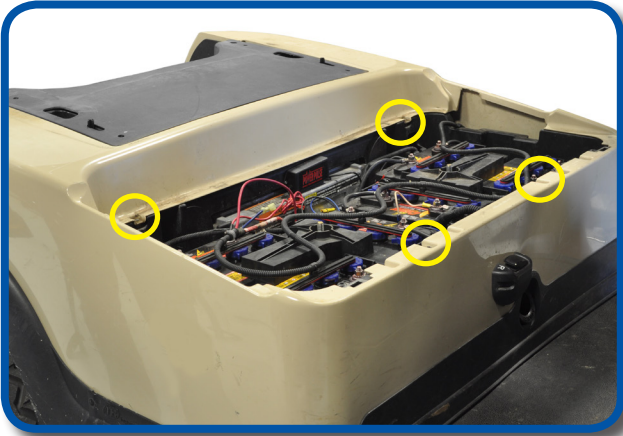

Remove seat. Loosen OEM body by removing 4 screws and retaining hardware.

Remove forward and reverse switch bezel, retain hardware and bezel.

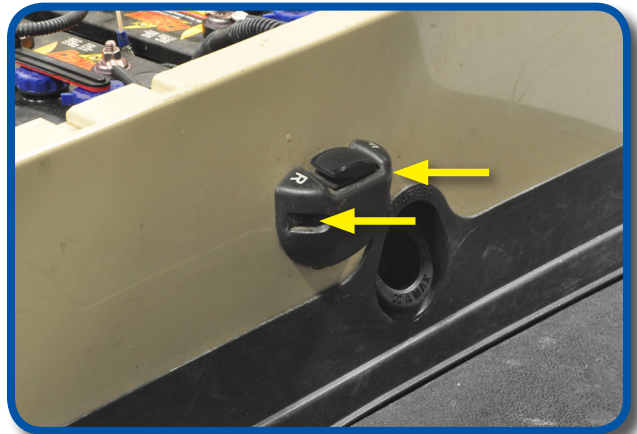

Take a picture of how your switch is connected for reinstallation purposes.

Now that the body is free, remove the rear body.



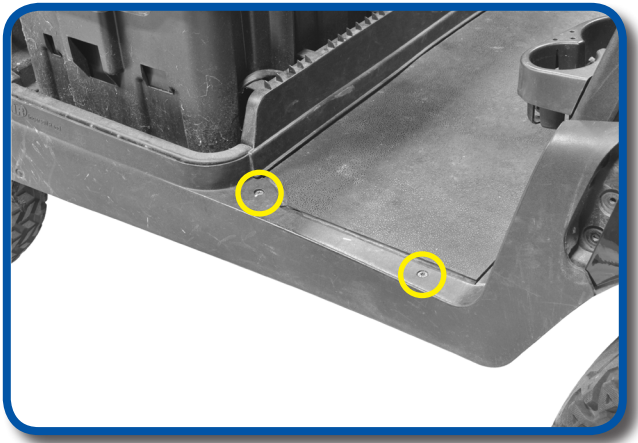

Remove and retain side rocker panels, then floor mat.

29

A) Remove and retain charge port trim bezel as shown.

B) Remove trim panel as shown. Retain all hardware.

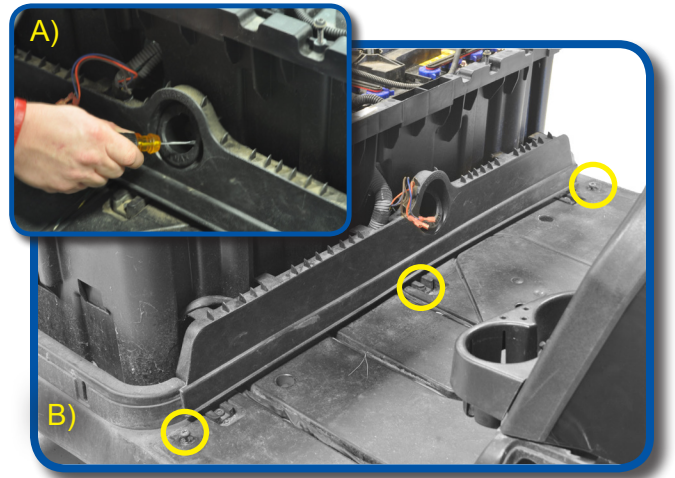

Remove dash access panel and retain.

31

ALPHA HARNESS INSTALLATION

Feed the Alpha bucket harness 12 pin plug through the battery box channel as shown.

Note: The Alpha tail lights use 4 pin connectors, basic bucket and pre-installed bucket harnesses will not work. This applies to aftermarket, factory gas carts, and factory 2008.5 and older carts.

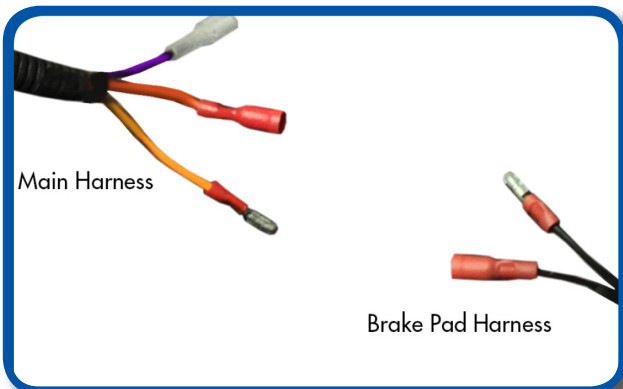
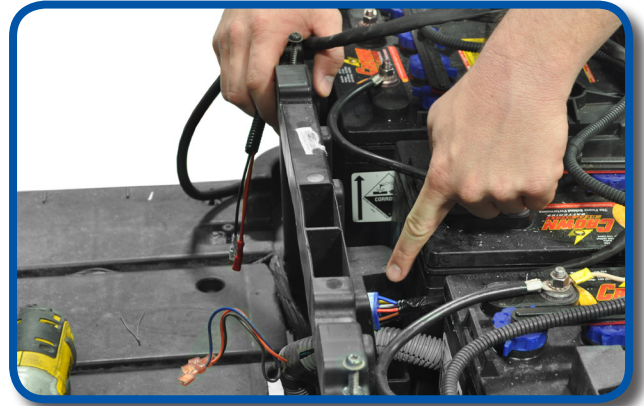

Remove and retain pedal assembly cover. Feed brake harness leg into pedal assembly as shown. If you are installing a light brake kit, do so now.

Note: Blue and Green wire on the Alpha harness will need to be jumped together for brake light operation.

Run Alpha bucket harness through channel in floor board and feed to the dash.

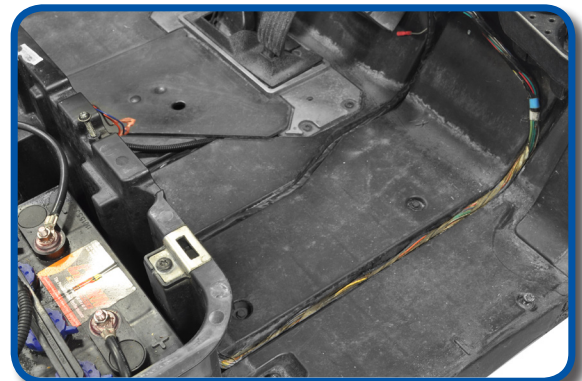

POWER CONNECTIONS

FUSE ASSEMBLY INSTALLATION

FOR GAS VEHICLES

Attach blue wire with the fuse holder to the positive battery post.

Attach the black wire to the negative battery post.

12 Volt Battery Installation (for vehicles without DC to DC converter)

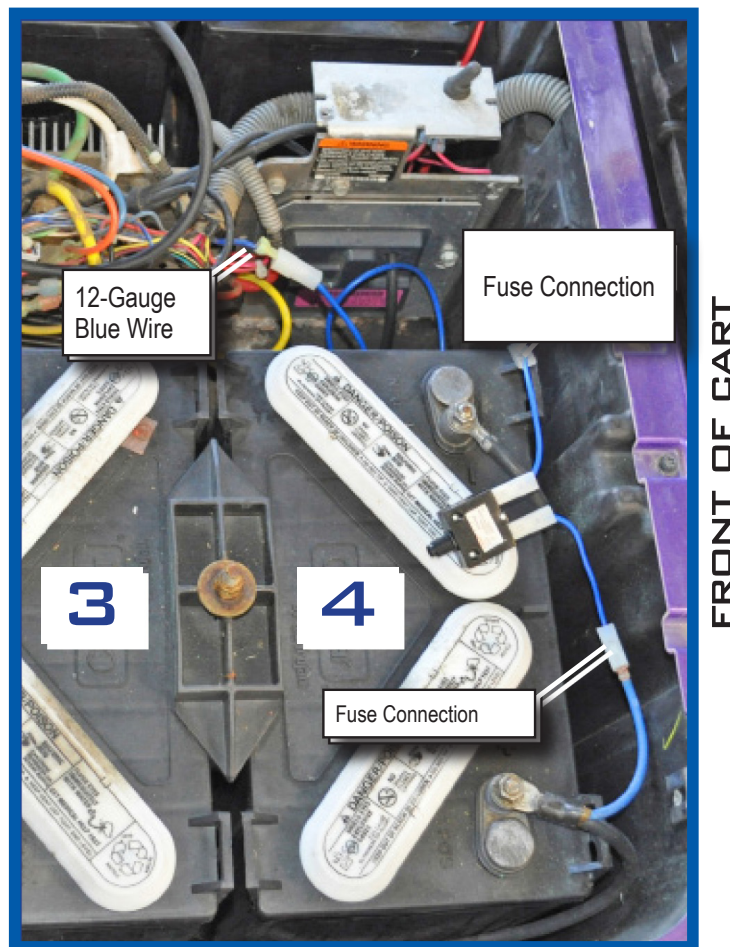

1. Remove the seat bottom and the electronic component cover located between the batteries.
2. Locate the blue wire leading from the #4 battery positive connection and connect to the long lead of the fuse assembly.
3. Locate the single 12 gauge blue wire with a spade terminal leading from the passenger side of the electronic component area and connect the short lead leading from the fuse assembly.
4. Secure all loose wires.
5. Replace the electronic component cover and test the lights.

POWER CONNECTIONS

FUSE ASSEMBLY INSTALLATION

FOR VEHICLES WITH 8 VOLT BATTERIES YOU MUST USE A DC TO DC CONVERTER

We recommend the use of either MADJAX part #'s
MJ1230C MJ1220C MJ1612VR

Follow the instructions supplied with your converter for the following steps. We recommend the use of a multi-meter to check the voltage for 12V + before light kit is turned on to ensure your converter is working properly.

PICTURE 4

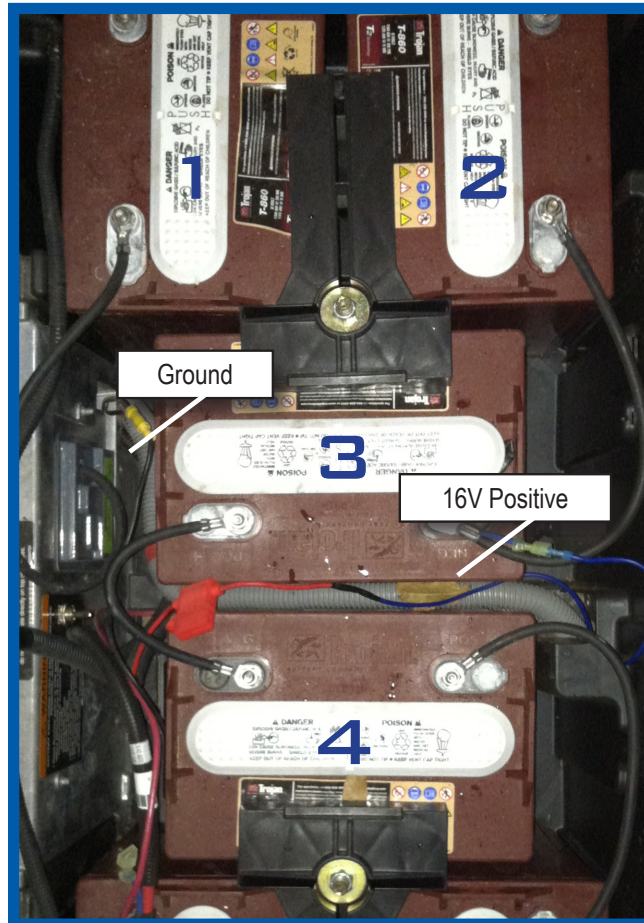

16VOLT CONNECTION FOR 8 VOLT BATTERIES WITH VOLTAGE REDUCER MaJ1612VR

1) The Ground or negative wire is located at the rear of the battery box behind battery #3. It is a black wire with a female Barrel terminal.

* 2) The 16 volt positive connection (SEE PICTURE 4) is located on Battery #3. It is a short blue wire with a spade terminal. It is located on the negative terminal as illustrated in the picture. This connection is used in conjunction with a 16volt to 12volt DC to DC converter.

POWER CONNECTIONS

FUSE ASSEMBLY INSTALLATION

48VOLT CONNECTION FOR VOLTAGE CONVERTER

3) The 48volt + (positive) connection is located on battery #6 as shown in picture 4. It is the short blue wire with spade terminal. ONLY USE THIS CONNECTION IN CONJUNCTION WITH A 48 VOLT TO 12 VOLT REDUCER/ CONVERTER OR BULB FAILURE WILL RESULT!!

****** Once you have your converter hooked up. The Blue wire on the bucket harness will hook to the 12 Volt output and the Black wire from the bucket harness will attach to the 12 volt negative.

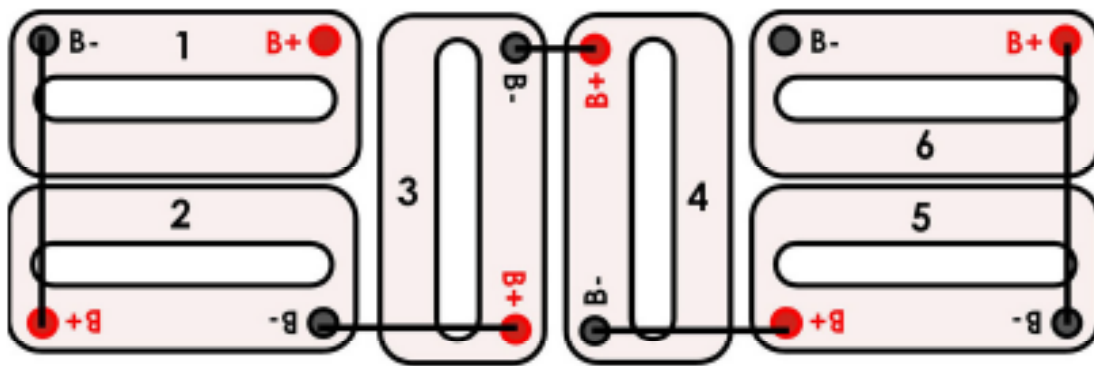

* For ERIC cars without OBC if using 16-12v Reducer MJ1612VR the 16Volt positive connection is positive post of battery 5. 16 Volt negative connection is negative post of battery 6.

**For ERIC cars without OBC if using the 48-12v Converter the 48Volt battery connection is positive post of battery 1. Negative connection is negative post of battery 6.

35

Take the 4 pin tail light connector with the **yellow wire** and run it through the passenger side rear access opening of the battery box. Repeat the process on the driver side.

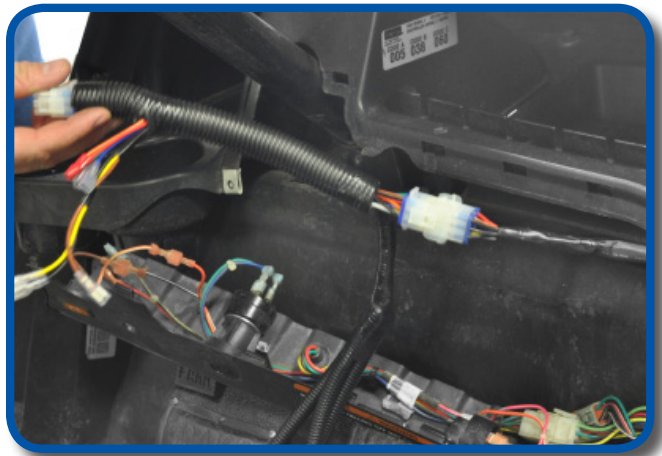
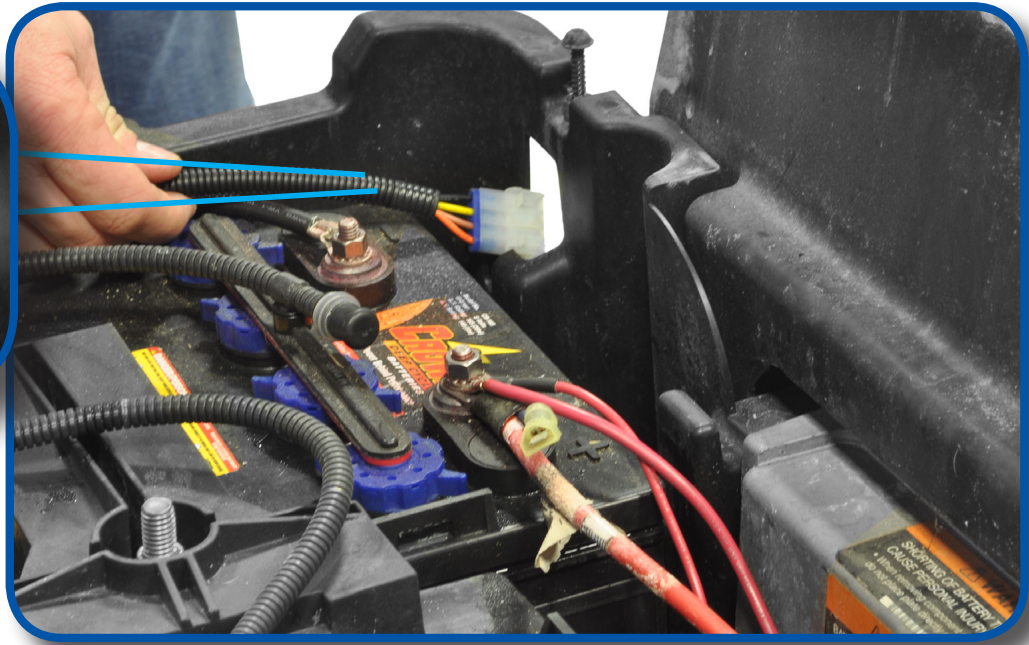

36

Attach Alpha bucket harness 12 pin connector to front light harness 12 pin connector as shown.

37

Run Alpha light harness through channel in dash to the front cowl.

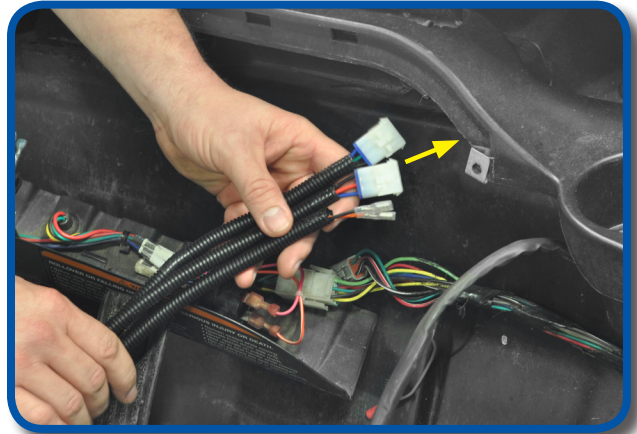

38

If you are installing an upgrade turn signal switch, do so now. Reattach panel when done.



39

Attach headlight to front harness. If you are going to use the Daytime running light feature unplug red/white wire from blue on both headlights wires and connect red/white wires to switched 12Volt output of voltage converter

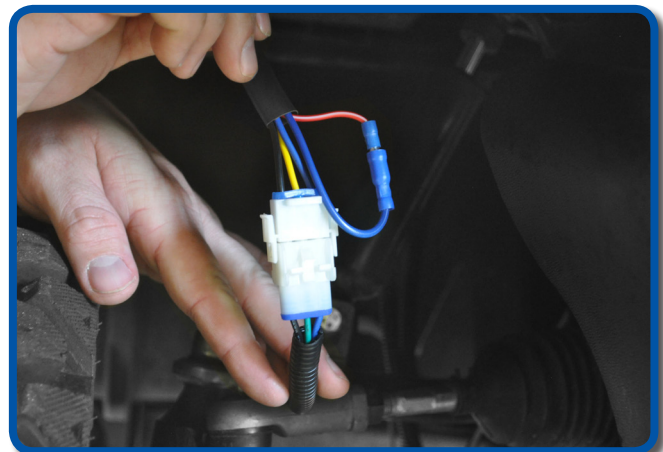

REAR BODY



Place body on cart. Reinstall floor mat, F-N-R switch, charge port trim and side rocker panels.

Starting at the front of the battery box, work body into channel of underbody and trim. Once the front is in place, reattach the two forward screws as shown.

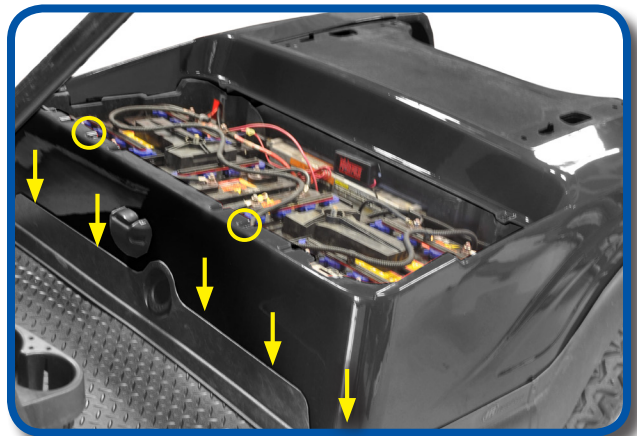

Now move to one side of the rear body and work that section into the channel. Once body is into position, reattach the retained screw at the battery box. Once this side is done, repeat process on other side.



43
Take passenger tail light (with red 4 pin connector) and attach the passenger side tail light bracket labeled (P)



44
Plug tail light harness into bucket harness.

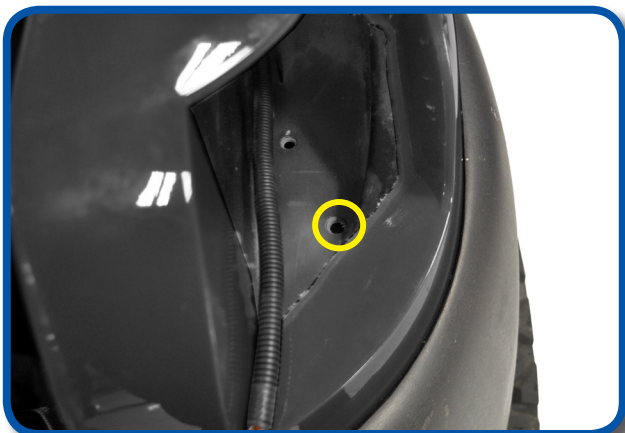
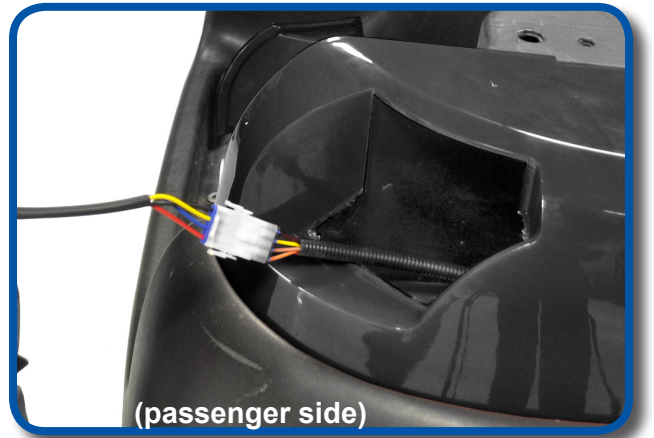

45
Locate the pre-drilled hole shown in your underbody.

Using the 8mmx45mm hardware, attach light mounting bracket to underbody from tire well as shown. Once bolt is started, tighten.

*This will be a way to quickly remove the tail lights.

Repeat process on other side.



Reattach all factory seats, top, struts, etc.



INSTALLATION COMPLETE

Club Car®, Precedent®, and DS® are registered trademarks of Ingersoll Rand, Inc. Reference to Ingersoll Rand's trademarks and products is solely for the purpose of identifying golf carts with which this Madjax product is compatible. Madjax products are aftermarket parts and are not original equipment parts. Madjax is not connected, affiliated with, or sponsored by Ingersoll Rand® or Club Car®.